

# MTN-FP50

AMD® Ryzen™ Mobile Processor based Compact Mini PC  
with Radeon™ Graphics



## Features

- CPU: AMD Ryzen Mobile Processors
- Memory: Dual Channel SO-DIMM DDR4 for Memory up to 64GB
- Display: AMD Radeon Graphics, Displays via 2xHDMI
- I/O Ports: 3xUSB3.2, 2xUSB2.0, 1xLAN, Audio
- Expansion: 1x M.2 for WiFi
- Storage: 1xM.2 for SSD, SATA3.0
- Power: 12V DC-in



## Introduction

The Maxtang MTN-FP50 is a compact mini PC based on the AMD Ryzen mobile processors, R1305G (SATA ONLY), 3020E, 2500U, and 3500U. It can provide excellent performance with greater space-saving. Supports Dual-channel SO-DIMM DDR4 up to 64GB, display via 2xHDMI. Features with one 10/100/1000 Mbps ethernet controller, M.2 and SATA3.0 for storage, addition M.2 for Wi-Fi. A rich I/O interface includes 3x USB3.2, 2xUSB2.0, 1xLAN, Line-out, Mic-in with standard 12V DC-in caters to most markets requirements.

The MTN-FP50 is an ideal solution for various applications. It retains the robust design of all Maxtang product lines at a new cost-effective price point. Its powerful features provide you an outstanding visual experience, increase your productivity with stability, reliability. Our goal is to provide the best products with high quality and cost advantages.

## I/O Interfaces

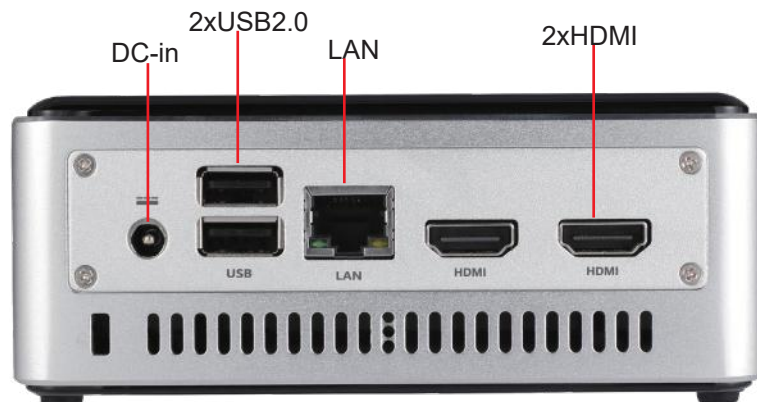
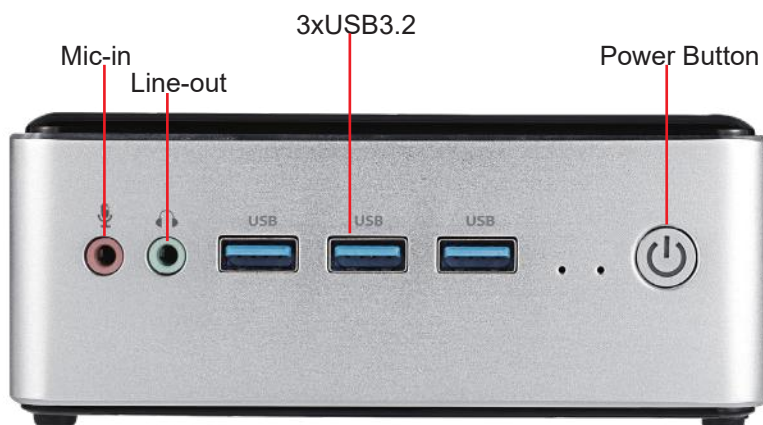

H/W Monitor



Watchdog



GPIO



Brightness



Wi-Fi



Bluetooth

## Technical Specifications

Processor	CPU	R1305G	2500U	3500U
	Max Boost Clock	2.8 GHz	3.6 GHz	3.7 GHz
	Base Clock	1.5 GHz	2.0 GHz	2.1 GHz
	Cache	L2 1MB	L2 2MB	L2 2MB
	BIOS	AMI UEFI BIOS		
Memory	Type	Dual Channel SO-DIMM DDR4		
	Max Capacity	64GB		
Display	GPU	Radeon™ Vega Graphics		
	Display Port	2x HDMI		
Ethernet	Speed	10/100/1000 Mbps		
	Controller	RTL8111H		
	Interface	RJ-45		
Audio	Audio Codec	Realtek HD		
	Interface	Line-out+Mic-in, Audio header, Amplifier header		
Hardware	CPU temperature, system temperature, onboard voltage, watchdog			
Storage	M.2	1x M.2 for 2280 SSD (NVMe only for 2500U/3500U)		
	SATA3.0	1x SATA3.0		
Expansion	M.2	1x M.2 for Wi-Fi and Bluetooth		
I/O Interface	HDMI	2		
	USB2.0	2		
	USB3.2	3		
	LAN	1		
	Line-out	1		
	Mic-in	1		
	DC-in	1		
	Dimension	Size	130 mm x 128 mm x 52mm (L x W x H)	
Power	Standard Port	12V DC-in		
Temperature	Operating Temp.	-0°C to 50°C		
	Storage Temp.	-20°C to 70°C		
Cooling	Active			
Operating System	Win 10 64bit, Linux 64bit			

\*All specifications and photos are subject to change without notice.

## Dimension(in mm)

1 Mic-in

2 Line-out

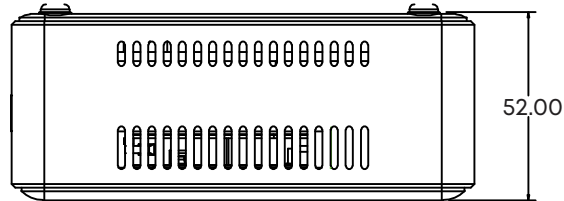

5 2x HDMI

6 LAN

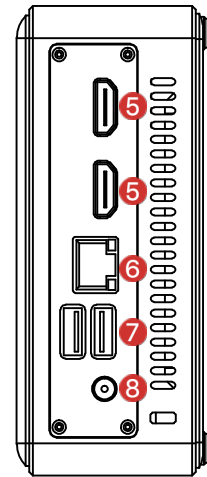
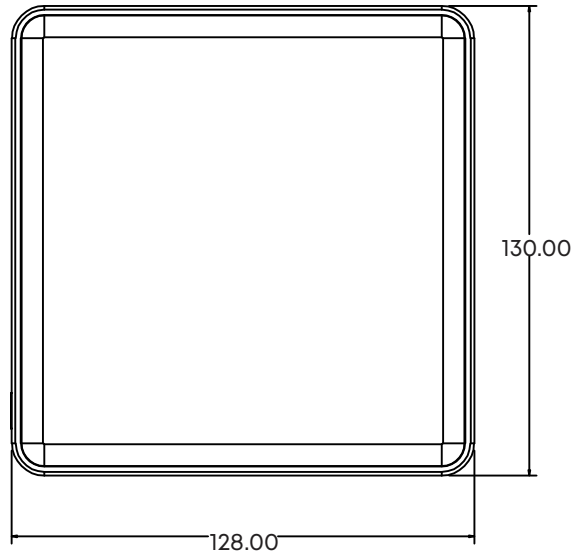
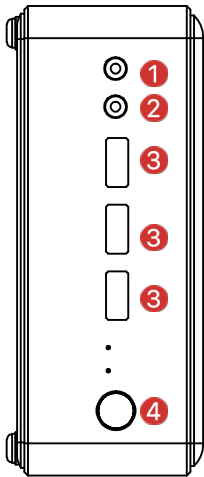

3 3x USB3.2

4 Power button  
(with LED)

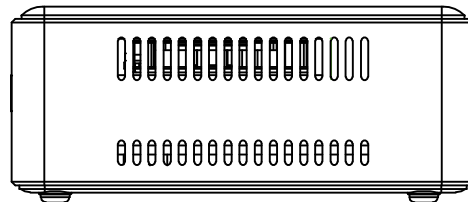

7 2x USB2.0

8 DC-in

Copyright ©2018 Maxtang Technology Co. Ltd. All rights reserved. All data is for information purposes only and not guaranteed for legal purposes. Information has been carefully checked and is believed to be accurate however, no responsibility is assumed for inaccuracies. Maxtang and the Maxtang logo and all other trademarks or registered trademarks are the property of their respective owners and are recognized.